

3246ES SCISSOR LIFTS

Platform

- 1.27 m roll-out deck extension
- Fold Down Handrails
- Half swing gate
- Removable platform console box
- Lanyard attach points
- Full proportional drive joystick control with integral thumb steer switch
- Proportional lift/lower speed control
- Joystick enable for lift and drive
- Load sensing system

Power & Transmission

- 4 x 6V 220 A/hr deep cycle batteries
- Automatic positive traction
- Programmable “Personality” settings
- On-board self-diagnostic testing
- Swing-out battery/electrical compartment doors
- 20 amp automatic battery charger
- Dual motor direct electric front wheel drive & steer
- Dual wheel automatic brakes
- Emergency brake release

Functional Equipment & Accessories

- Pothole protection system
- AC cable to platform
- Battery condition indicator
- Hour meter
- Drywall gate
- Lubrication free scissor arm bushings
- Scissor maintenance prop
- Manual descent
- Horn
- Non-marking solid tyres (406 x 125)
- Variable slope sensing
- Slope alarm and light
- Tie down lugs
- Fork lift pockets

Available Options

- 13mm air line to platform
- Platform work-lights
- 220A/hr maintenance free AGM batteries in lieu of standard
- 245 Amp-hour batteries in lieu of 220 Amp-hour batteries
- Lifting lugs
- All motion alarm
- Descent alarm
- Alarm package ¹
- Platform padding
- Panel Carrier
- Pipe Racks
- Workstation c/w 12V outlet
- Workstation w/o 12V outlet
- Electricians’ Package ²
- Plumbers’ package ³
- Amber strobe light
- Plugs & Sockets



¹ Includes all-motion alarm + amber strobe light.

² Includes workstation without 12 V outlet, pipe racks, vice and electricians tree.

³ Includes workstation with 12 V outlet, pipe racks and vice.

Certain options or country standards may increase weight and/or dimensions.

3246ES SCISSOR LIFTS

A. Platform Height – Elevated	9.68 m
B. Platform Height – Lowered	1.26 m
C. Platform Railing Height	1.10 m
D. Stowed Height (Rails Folded)	2.01 m
E. Platform Size (W x L)	1.12 m x 2.50 m
F. Deck Extension	1.27 m
G. Overall Width	1.17 m
H. Overall Length	2.50 m
I. Wheelbase	2.09 m
J. Ground Clearance	0.13 m
Platform Capacity ¹	320 kg
Capacity on Optional Deck Extension	120 kg
Lift/Lower Time	50/60 sec.
Maximum Drive Height	9.68 m
Machine weight ²	2,905 kg
Maximum Ground Bearing Pressure	6.98 kg/cm ²
Drive Speed - Lowered	4.0 km/h
Drive Speed – Elevated	0.8 km/h
Gradeability	25%
Turning Radius – Inside	Zero
Turning Radius – Outside	2.41 m
Tyres (Non-Marking Solid)	406 x 125
Brakes	Automatic Friction - Front
Drive	24V Electric 6 kW
Batteries	4 x 6V 220 A/hr
Charger (120/240V – 50/60HZ)	20 Amp Automatic
Pump Motor	3 kW
Hydraulic System	20.0 L

JLG Industries, Inc. is a leading designer and manufacturer of access equipment and complementary services and attachments.

JLG has manufacturing facilities in the United States, France, Romania, China and Belgium. Customers throughout Europe, Scandinavia, Africa and the Middle East benefit from a network of dedicated sales and service operations designed to deliver the highest levels of support.

JLG is an Oshkosh Corporation company.

www.jlgeurope.com

¹ Capacities shown are maximum with 2 persons indoor on all models. Outdoor ratings are: 3246ES – 2 person / 320 kg.
² Certain options or country standards may increase weight and/or dimensions.

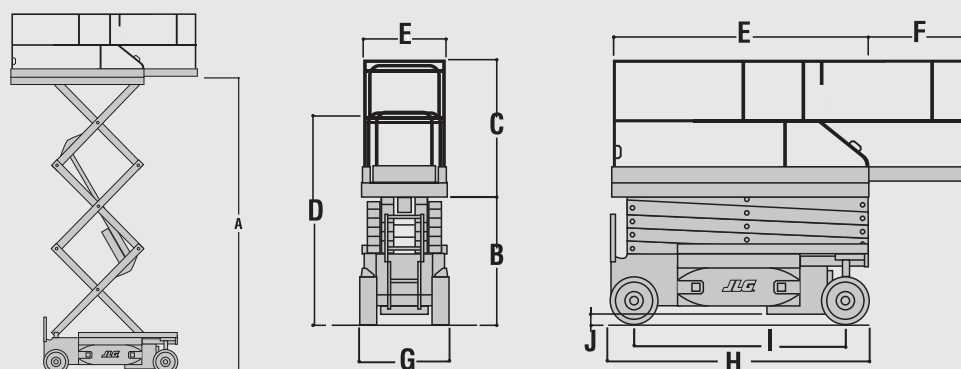

JLG is continually researching and developing products and reserves the right to make modifications without prior notice. All data in this document is indicative. Certain options or country standards will increase weight. Specifications may change to meet country standards or with the addition of optional equipment.